

LCN 9140 SERIES

FEATURES

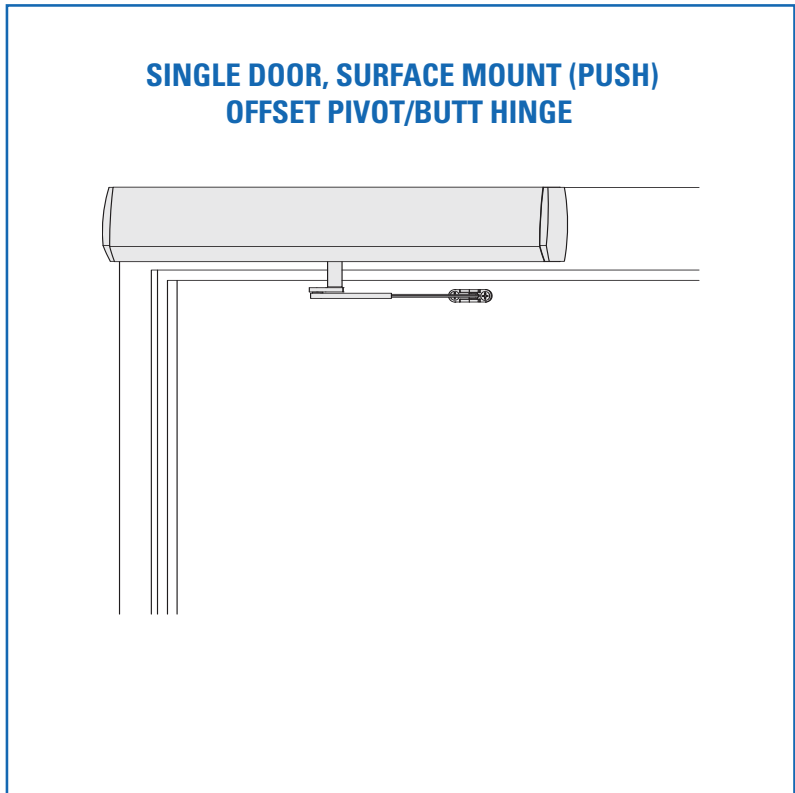

The 9140 BENCHMARK by LCN is an electrically powered low-energy operator. It provides easy access for people with disabilities, the elderly or the frail. Designed primarily for automatic opening applications that occasionally require manual opening. The BENCHMARK is a cost-effective solution for retrofitting an activated or manual door.

- ▶ Push 'N Go permits non-switch activation
- ▶ Microprocessor control box ensures reliability and maintains customer settings
- ▶ Power Boost allows for increased closing force near latch

- ▶ 9140 series operator is shipped with motor gearbox, control box, mounting plate, regular arm, metal cover, standard track, wood and machine screw pack. Actuators available separately, see page 121.
- ▶ Single interior door, surface mounted.
- ▶ ADA compliant.
- ▶ On/Off switch included as standard.
- ▶ Non-handed for either right or left swinging door.
- ▶ 27" cover is standard, 36" optional.
- ▶ All potentiometers clearly labeled with their functions.
- ▶ LED lights indicate power to control box and motor gearbox.

9140 Series is fully compliant with UL 325 and meets the provisions of ANSI A156.19. The 9140 Series is UL listed for fire-rated applications. The 9140 Series also meets the provisions of the Americans with Disabilities Act.

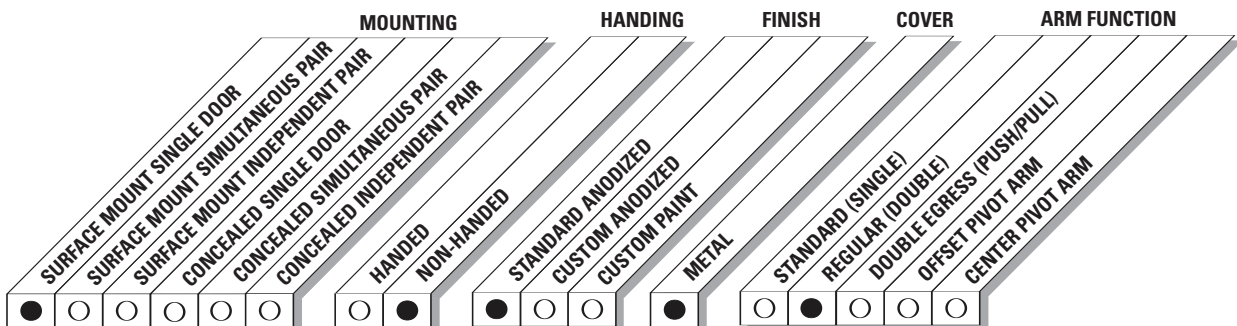

● AVAILABLE
○ NOT AVAILABLE

LCN 9140 SERIES

MOUNTING DETAILS

TOP JAMB SINGLE DOOR (OFFSET/BUTT HINGE, CENTER PIVOT, PULL, STANDARD COVER) MOUNTING

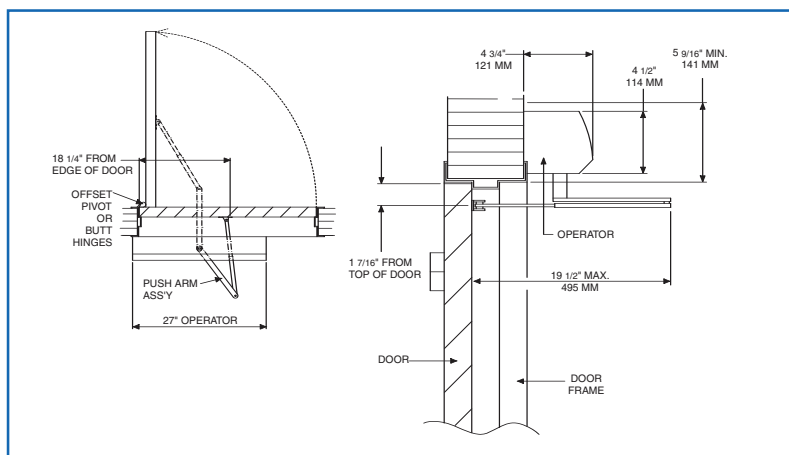

TOP JAMB SINGLE DOOR (OFFSET/BUTT HINGE, CENTER PIVOT, PULL, FULL COVER) MOUNTING

MAXIMUM OPENING

Template allows 90 degree power opening and 90 degree manual opening.

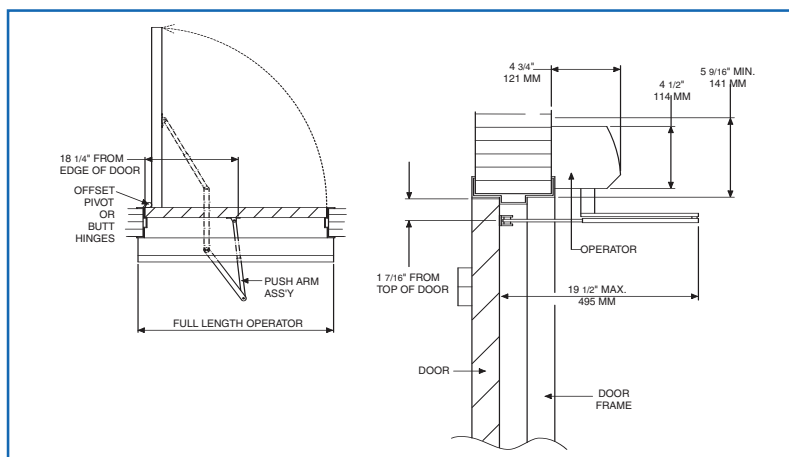

- ▶ **Butt Hinges** should not exceed 5" (127 mm) in width.
- ▶ **Reveal** for push installations should not exceed 6" (152 mm) for REGULAR ARM and 9 3/4" (248 mm) for LONG ARM.
- ▶ **Head Frame** minimum 2" (51 mm).
- ▶ **Top Rail** minimum 2" (51 mm). Flush ceiling installation requires 5 1/4" (133 mm) minimum.
- ▶ **Opening and Closing Time** are variable by adjustments to the electronic control module located on the operator assembly. Maximum hold open time adjustable up to approximately 30 seconds.
- ▶ **System Diagram** see "AUTOMATIC OPERATORS" section pages 52-54 for typical system wiring and page 55 for electrical data.
- ▶ Please consult your local SSC representative or LCN for assistance with specific installations and material requirements.

Special Templates

Customized installation templates or products may be available to solve unusual applications. Contact LCN for assistance.

LCN 9140 SERIES

MOTOR GEARBOX

MOTOR GEARBOX ASSEMBLY, 9140-3454S

Driving mechanism for operator. For 27" unit. Switch included.

MOTOR GEARBOX ASSEMBLY (W/O SWITCH), 9140-3454

Driving mechanism for operator. For full length unit. Switch not included.

BRACKETS

MOUNTING BRACKET, 9140-3018

Standard mounting bracket.

SWITCH BRACKET – 29" CABLE, 9140-3351-1

Bracket used to locate switch at end of cover on full length unit.

SWITCH BRACKET – 41" CABLE, 9140-3351-2

Bracket used to locate switch at end of cover on full length unit.

SWITCH BRACKET – 51" CABLE, 9140-3351-3

Bracket used to locate switch at end of cover on full length unit.

CONTROL BOXES

CONTROL BOX, (120v), 9140-3462

Electronic controlling device with power supply output and power boost feature for Benchmark.

COVERS

METAL COVER, 9140-72MC

Standard, 27", non-handed, extruded aluminum cover.

FULL METAL COVER, 9140-72FC

36" Full length, non-handed, extruded aluminum cover.

COVER INSERT 9140-163

Used to cover operator shaft opening.

COVER END CAP INSERT, 9140-163-1

Used to cover switch hole opening.

COVER END CAP, 9140-334

Black plastic end caps.

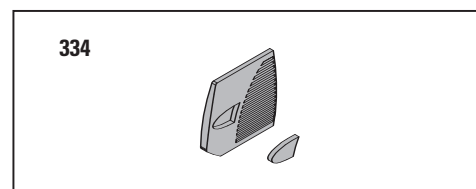
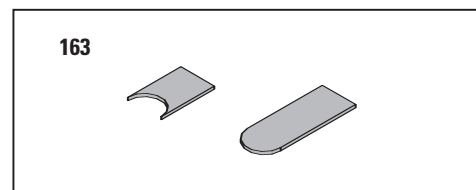
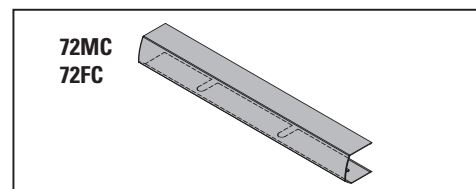
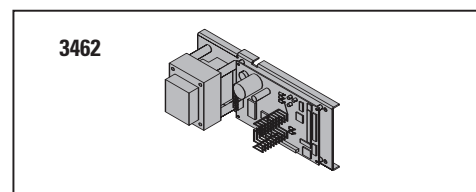
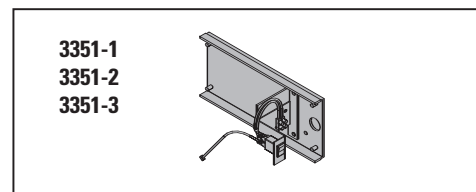
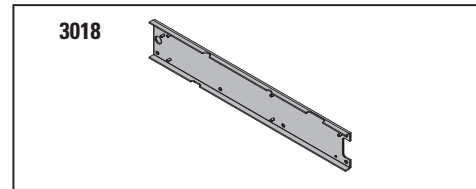
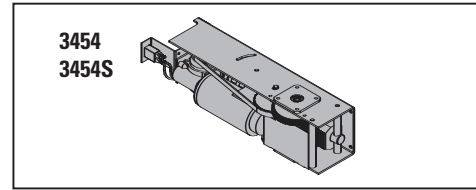

LCN 9140 SERIES

ARMS

REGULAR ARM, 9140-3077

Non-handed arm.

LONG PUSH ARM, 9140-3077L

Non-handed long arm.

ROD & SHOE, 9140-79

Rod for use with regular arm.

LONG ROD & SHOE, 9140-79LR

Long rod for use with long arm.

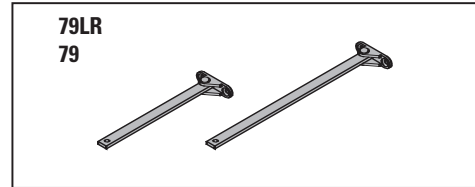
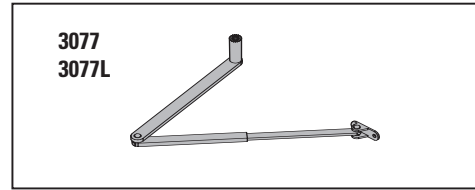

LCN 9140 SERIES

TABLE OF SIZES

→ Indicates recommended range of door width for operator.
Note: For All Benchmark Series
26" minimum door width for 27" push operator
36" minimum door width for full length push operator

DOOR WIDTH

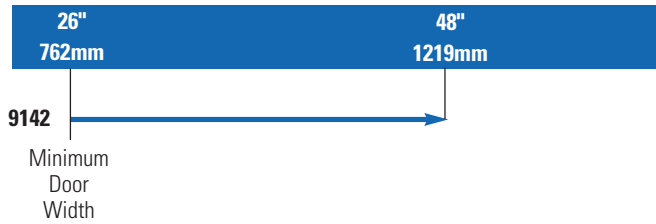

HOW-TO-ORDER 9140 SERIES OPERATORS

1. SPECIFY FINISH.

- Standard Anodized Finish _____
Aluminum or Dark Bronze

Operator will be shipped with:

- STANDARD MOTOR GEARBOX (SF)
 - STANDARD CONTROL BOX (SC)
 - MOUNTING BRACKET
 - 27" METAL COVER (CL27)
 - REGULAR ARM (3077)
 - WOOD and MACHINE SCREW PACK
- Unless options listed below are selected.*

OPERATOR OPTIONS

COVER

- 36" Full Cover

ARM

- Long Arm (3077L)
(reveals 6" to 9 3/4")

SPECIAL TEMPLATE

- ST- _____